

FT_{DX}-400

SSB TRANSCEIVER



YAESU MUSEN CO., LTD.

TOKYO JAPAN.

GENERAL:

The model FT-DX-400/500 Single Sideband Transceiver is a precision built high performance transceiver providing SSB (USB and LSB selectable), CW, and AM modes of operation. This transceiver operates at a maximum input of 500 watts PEP for SSB, 440 watts for CW and 125 watts AM on all bands, 80 through 10 meters. The FT-DX-400/500 transceiver is capable of 400 watts PEP input under steady state two-tone test conditions before flat-topping, however the Peak Envelope Power, when voice modulated, is more than 500 watts.

The transceiver is self-contained in that it requires only a microphone, a speaker, and an antenna.

A specially designed high frequency crystal lattice filter is utilized for the sideband generation. The clarifier is provided to shift the receiver frequency approximately 5 Kc either side of the transmitting frequency. The clarifier may be switched so that it will lock the receiver frequency to the transmitting frequency. It may also be used for vernier tuning of the main dial.

Provisions have been made for the use of an external VFO unit. A switch on the front panel selects the transmitter to an external VFO control mode. This feature provides the operator with independent transmitting and receiving frequency operation. Moreover, this switch can also select four crystals for crystal control operation.

In addition to the reception of normal amateur bands, it is possible to operate 3 extra 500 Kc bands as provided by the band switch.

Other features include a built-in voice control system, 100Kc/25Kc multivibrator calibrator circuitry, and provision has been made for using our linear amplifier FL-2000.

SPECIFICATIONS

Emission type	SSB (USB and LSB selectable), CW, AM
Input power	500 watts PEP maximum, 125 watts for AM 440 watts CW.
Frequency range	3.5—4.0, 7.0—7.5, 14.0—14.5, 21.0—21.5, 28.0—30.0 Mc (3 extra bands can be added).
Frequency stability.....	After warmup 100 cps for any 30 min.
Antenna Impedance	50 to 120 ohms unbalanced
Carrier suppression	More than -40 db
Sideband suppression	More than -50 db at 1000 cps
Distortion products	Better than -25 db
Receiver sensitivity	0.5 μ V S/N 20db at 14 Mc SSB

SPECIFICATIONS CONT

Selectivity	2.3 Kc at -6 db, 3.7 Kc at -55 db
Image rejection	50 db
Audio output	1 watt at 5% distortion
Output impedance	4 and 600 ohms
Power requirement	AC 117 or 220 volts at 50/60 cps
Dimension	15 3/4" wide, 6 1/4" high, 13 3/4" deep
Weight	approximately (50 lbs)

BLOCK DIAGRAM

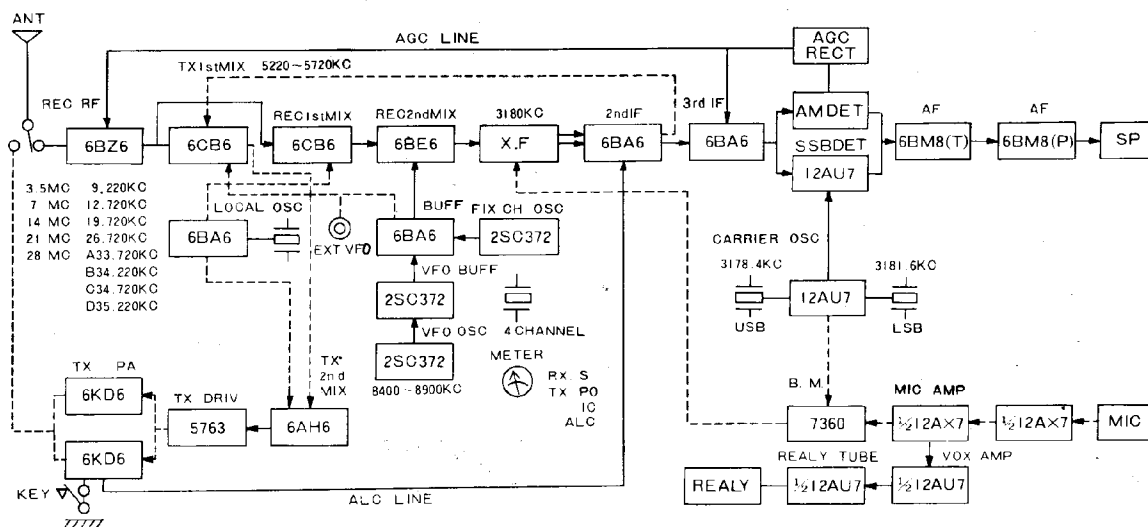

PRINCIPLES OF OPERATION

The block diagram and the circuit description provides you with a better understanding of this transceiver. The transceiver consists of a double-conversion receiver and a double-conversion exciter-transmitter. Receiver and transmitter circuits use common oscillators, common crystal filters, and common IF stages. The low frequency IF is 3,180 Kc, and high frequency IF is 5,220 to 5,720 Kc. The high frequency IF is tunable and covers 500 Kc.

RECEIVER CIRCUIT;

A signal from the antenna passes through the antenna relay and trap coil to the tuned circuit and is applied to the grid of the RF amplifier, V1, 6BZ6. This trap circuit minimizes interference caused by the signals in the first IF range. Amplified signals from V1 are applied from the tuned circuit consisting of C10 and band switch selected coils to the grid of the receiver first mixer V201, 6CB6.

The high frequency oscillator injection signal is also fed to the grid of the first mixer from the local oscillator V2, 6BA6. The product of the first mixer is applied from the plate of the tube to the variable IF transformer. Output of this transformer (5,220 to 5,720 Kc) is applied to the grid of the second receiver mixer, V203, 6BE6. When the signal is applied to the grid of V203, and the VFO injection signal is applied to another grid of the tube, the 3,180 Kc difference product is fed from the V203 plate to the crystal filter. The output

from the filter is applied to the grid of the first IF amplifier, V204 6BA6. The signal is amplified by V204 and V205 and applied through L205 to the AM detector, AVC rectifier diodes, and the grid of product detector V213, 12AU7.

The beat-frequency oscillator signal which is delivered from V206, 12AU7 is applied to the cathode of V213, and the result is the detected audio signal. Output of the AVC rectifier circuit is applied to the grid circuit of RF amplifier tube and IF amplifier tube to control the gain of the receiver automatically and prevents overloading. Output from the AM detector or the product detector is applied through MODE switch to the noise limiter circuit by a switch in front panel. Output from the noise limiter circuit is applied through the AF GAIN control, VR9, to the grid of the first AF amplifier tube, triode section of V210, 6BM8. Amplified audio output of the triode section is coupled to the grid of the AF output amplifier, pentode section of V210, of which the plate is connected to the output transformer T1.

TRANSMITTER CIRCUIT:

The microphone input is connected to the grid of the first audio amplifier V208A, 12AX7, and then coupled to the grid of the second audio amplifier, V208B, the other half of the tube. Output from V208B is coupled to the beam deflection electrode of V207, 7360, through the MIC GAIN control, VR-6.

In the TUNE position of the MODE switch, output from the tone oscillator, V212, 6U8, is fed to the grid of the second audio amplifier. This signal is also fed to the grid of the first receiver A-F amplifier tube, V210, through the AUDIO GAIN control. The carrier signal generated in V206, 12AU7, is fed to the control grid of V207. Output from the balanced modulator V207 coupled to the grid of the IF amplifier, V204, 6BA6, through the crystal filter, XF-201 of which the passband is centered at 3,180 Kc. This passes either the upper or lower sideband, depending upon the sideband selected when the MODE switch is set to carrier crystal X201 or X202.

The output from the IF amplifier is fed through L204 to the grid of transmitter VFO mixer, V201, 6CB6. The plate circuit of the first mixer is connected to the tunable IF coil L202, and converts the 3,180 Kc sideband signal to a 5,220 to 5,720 Kc single sideband signal. The tunable IF network is so designed that it provides excellent spurious reduction. The output signal from the tunable IF network is fed to the grid of the second mixer, V3, 6AH6, and the high frequency injection signal from crystal oscillator, V2, 6BA6 is also fed to the grid of V3. This arrangement converts the IF signal to the desired transmitting frequency. Output from the second mixer is fed through a tuned circuit to the grid of the driver tube, V4, ~~6AB6~~, and amplified to a level sufficient to drive the final linear amplifier, V5 and V6, 6KD6s.

Final output from V5 and V6 is fed to a pi-section network consisting of L15 and PLATE and LOAD capacitors. A section of the bandswitch adjusts the inductance of L15 to the correct value for each band, and adds fixed amounts of capacity to the LOAD capacitor on the lower bands. Output from the pi-network is fed to the antenna through contacts of the transmit and receive relay. Both the driver and final stages are neutralized to ensure stability. A section of the band switch selects the capacitors to the correct value for perfect neutralization on each band.

The ALC circuit is placed in the grid circuit of the final tubes. When RF driving voltage to the final tubes becomes sufficient to drive the grids positive, the grids begin to draw current and the signal is detected. This produces an audio envelope. The audio is rectified by the ALC rectifier, which in turn produces a negative DC voltage. The voltage is filtered by C61, C62, R29 and R30, which also determines the time constant, and is used to control the gain of V204. The ALC voltage is grounded by the mode switch on CW and TUNE positions. This system allows a high average level of modulation without increased distortion.

Audio output voltage from the second microphone amplifier, V208, is coupled through the VOX GAIN control to the grid of V209A, 12AU7, and fed to the VOX rectifier. The positive DC output voltage of the VOX rectifier is applied to the grid of VOX relay amplifier tube, V209B, 12AU7, causing it to conduct current and actuate the VOX relay RL1. The relay tube is so biased that the relay is actuated by the FUNCTION switch in the MOX position. Contacts on the relay switch, -100 volts DC muting and bias voltage, the metering circuit from receive to transmit, the clarifier circuit, and a pin of the remote socket to the ground on transmit. Plate current of V4 and V1 actuates the antenna relay RL2. The antenna relay also operates the FUNCTION switch in the CAL position to disable the receiver RF amplifier tube for easy and clear calibration.

The ANTITRIP circuit provides a threshold voltage to prevent the loud speaker output from tripping the transceiver into the transmit function. The receiver output audio voltage is connected through ANTITRIP control, VR8, to a rectifier. Negative DC output voltage from the ANTITRIP rectifier, connected to the grid of the VOX tube V209B, 12AU7, provides the necessary antitrip threshold. ANTITRIP control VR8 adjusts the value of the antitrip voltage threshold so that the loudspeaker output will not produce too much positive DC output from the VOX rectifier so as to exceed the negative DC output from the antitrip rectifier and cause V209B to actuate the relay. However, the microphone input will cause the positive voltage to overcome the negative voltage and actuate the relay.

Relay hold time will be determined by DELAY control under top cover.

OSCILLATORS

The transceiver contains six oscillators. They are the carrier oscillators, two high frequency crystal oscillators, the variable frequency oscillators, the tone oscillator, and the crystal calibrator.

Carrier oscillator

The carrier oscillator is crystal controlled at either 3,178.4 or 3,181.5 Kc, depending upon whether V201 or V202 is selected by the MODE switch. The mode switch disconnects the cathode circuit of either tube when not in use. These crystal frequencies are matched to the pass band of the crystal filter, so that the carrier frequency is placed approximately 20 db down on the skirt of the filter response. The 3,181.5 Kc crystal frequency is shifted into the filter response range to insert the carrier on AM and CW position of MODE switch.

High frequency oscillators

One of the high frequency oscillators is used instead of the variable frequency oscillator for crystal controlled operation. A silicon transistor, TR 701, 25C 372, is used for the crystal controlled oscillator, and its output is fed to the VFO buffer, V211, 6BA6, through the SELECT switch. The relation between the operating frequency and the crystal frequency is shown on the table, page 15. The other is used to set the desired band. This oscillator, V2, 6BA6, is crystal controlled by one of 8 crystals selected by the BAND switch. Output from the oscillator is fed to the cathode of the receiver first mixer V202, 6CB6, and the grid of the transmitter second mixer, V3, 6AH6. The output frequency of this oscillator is always 5,720 Kc higher than the lower edge of the selected band. The output signal from this oscillator is the crystal fundamental frequency for 80 and 40 meter, but for higher bands, the crystal frequency is tripled in the plate circuit of the oscillator.

Variable frequency oscillator

The VFO uses a silicon transistor, TR401, 2SC372, as the oscillator, and TR402, 2SC372 as the buffer. The oscillating frequency is 8,400 to 8,900 Kc, and the variable capacitor is ganged to the tunable IF stage. Varactor diode IS145 is in series with capacitor, C402, and is switched into the circuit by the CLARIFIER select switch and relay contacts to shift the VFO frequency. Output from TR402 is fed through the SELECT switch to

VFO buffer tube V211.

Tone oscillator

The tone oscillator operates when the MODE switch is in CW or TUNE position. It is a phase shift oscillator operating at approximately 8000 cps. The output is fed to the transmitter audio circuit for tuneup of the transmitter. Some of the output from the tone oscillator is applied to the receiver audio amplifier for sidetone monitoring in CW operation.

Crystal calibrator

The 100 Kc crystal oscillator, TR301, 2SC367 is used for dial calibration. Output from the buffer transistor, TR302 is fed into the 25 Kc multivibrator which generates a marker signal at every 25 Kc.

POWER SUPPLY

The built-in power supply is an all solid state bridge-type, delivering 4 different DC voltages and also AC heater supply for all tubes. The power transformer has two primary windings for operation from either 117 or 220 volt AC supply.

The power amplifier plate voltage (800 V DC) is supplied from bridge connected silicon rectifiers. 300 volts DC is delivered to the plates of the other tubes, and 150 volt DC supply is provided through the center tap of the medium voltage supply. Bias is supplied from a half wave rectifier, D513, SH-1. The plate voltage for all oscillator tubes is regulated with a VR-105 MT, stabilizer tube.

METER CIRCUIT

The same meter is used for both transmit and receive. In the RECEIVE position it functions as an S meter. In the TRANSMIT position by selection it will indicate total cathode current of the PA stage, A.L.C., or may be used to show relative power output.

INSTALLATION

It is recommended that an excessively warm location be avoided. The transceiver should be placed in a location that has adequate space so as to permit free air circulation through the cabinet openings. Check the primary input voltage of the transceiver before connecting to the power outlet. The peak power consumption is approximately 600 watts.

The transceiver should be connected to a good ground by a heavy lead to the terminal marked GND on rear apron of the chassis. It is not recommended that a gas pipe or electrical conduit pipes be used. The ground lead should be as short as possible.

Impedance of the antenna is designed to match a 50 to 120 ohm load. Most commercial antenna and feeders are designed between 50 and 75 ohms. If the impedance is far from this value, an antenna matching device should be placed between the antenna terminal and the feeder.

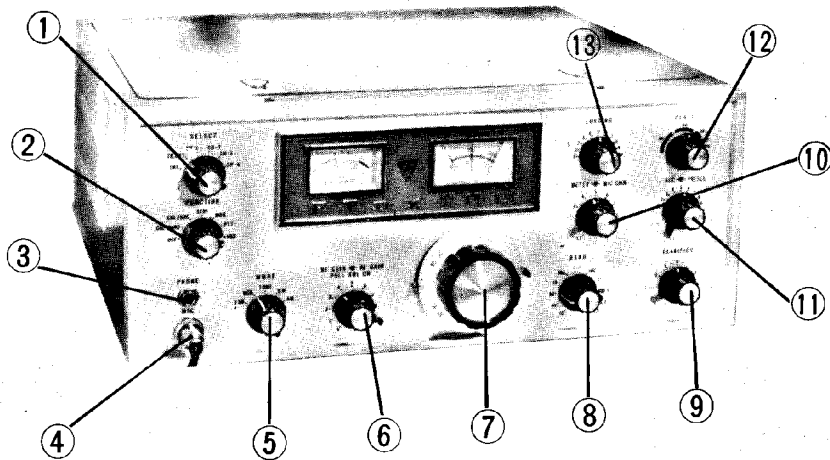

- ① **SELECT** INT: Operating frequency is determined by main tuning dial.
EXT: Receiver frequency is determined by the main dial, and transmitter frequency by an external VFO.
- ② **FUNCTION** CH-1 to CH-4: Crystal controlled operation.
OFF: Line voltage to transceiver is off.
STBY: All voltages are applied to transceiver.
CAL 100 KC: 100 Kc calibrator is on.
CAL 25 KC: 25 Kc multivibrator is on.
MOX: All circuits for transmit are energized.
PTT: Ready to transmit with PTT switch on the microphone.
VOX: Ready to transmit for voice operation.
- ⑤ **MODE** USB/LSB: Side band operation.
TUNE: Use for transmitter tune-up.
CW: Code operation.
AM: Carrier and one sideband operation.
- ⑥ **RF GAIN** Controls the gain of RF and IF stages.
- ⑥ **AF GAIN** Varies the gain of receiver audio amplifier, and automatic noise limiter is disconnected at pull position.
- ⑦ **MAIN TUNING** Determines operating frequency.
- ⑧ **BAND** Selects the coils for desired band operation.
- ⑨ **CLARIFIER** Varies the VFO frequency slightly for receiver incremental tuning, and is also used as the vernier of main dial.
- ⑩ **METER** Selects the meter to read PA cathode current, relative power output or plate current of ALC controlled stage.
- ⑩ **MIC GAIN** Controls microphone gain for transmitter, and tone signal input for tune-up.
- ⑪ **AGC** Changes receiver AGC release time constants.
- ⑪ **PRESELECT** Preselector for receiver and also tuning of driver stages for transmitter.
- ⑫ **PLATE** Tunes the plate circuit of PA tubes.
- ⑬ **LOADING** Tunes the output circuit of PI network.

OPERATION

INITIAL CHECK

Prior to connecting the transceiver to power outlet, carefully examine for any visible damage, check that all tubes and crystals are properly seated in their sockets, and check tuning controls and switches for complete freedom of action. Connect the speaker cable to socket marked SP on rear apron of the chassis, and an antenna cable to the coaxial cable connector. Make sure that supply voltage is the same as the voltage marked on the rear apron of the chassis before connecting to power outlet. Set FUNCTION switch to OFF. Set MIC GAIN control fully counterclockwise. Set the FUNCTION switch to STBY. The transceiver is now in the receive condition during the warmup, and the S-meter will slowly come up to full scale.

METER ADJUST

Turn meter switch to the ALC position, and the adjust ALC control until meter reading shows exactly full scale. S-meter adjustment: Disconnect antenna. Adjust S-meter control under top cover until meter reads exactly full scale. Reconnect antenna for normal operation.

BIAS ADJUST

After warmup, set MODE switch to USB, METER to IC, and the FUNCTION switch to MOX for transmit condition. The meter will indicate PA plate current. It should be approximately 50 ma. If plate current is other than 50 ma, adjust BIAS potentiometer under top cover.

RECEIVER TUNING

Set the controls as follows:

FUNCTION	STBY
MODE	Desired operation mode
BAND	Desired band
MIC GAIN	Fully counterclockwise
RF GAIN	Fully clockwise
SELECT	INT
CLARIFIER	OFF
AGC	FAST

Adjust the AF GAIN control until some receiver noise is heard in speaker. Peak the PRESELECTOR for maximum S-meter reading. For calibration, turn the FUNCTION switch to CAL 100 Kc position. Rotate the dial to nearest 100 Kc point and carefully adjust tuning for zero beat. Holding the outer tuning knob tightly, rotate the subdial (skirt) to the zero mark.

The red scale on the main dial corresponds to the band marked in red on the BAND switch and starts from 500 Kc. For example, if the hairline is at 500 red on the 10 B band, the receiving frequency is 28,500 Kc. FUNCTION switch, at CAL 25 Kc, marker signal is heard every 25 Kc. For SSB or CW operation, the AGC switch is usually set to SLOW.

TRANSMITTER TUNING

Set controls as follows:

SELECT	INTERNAL
FUNCTION	STBY
MODE	TUNE
MIC GAIN	Fully counter clockwise
AF GAIN	Normal listening level
METER	IC Position
CLARIFIER	OFF
BAND	Desired band
PLATE	Desired band
LOADING	To position shown in table

LOADING POSITIONS.	
BAND	LOADING
80.....	4
40.....	2.5
20.....	5
15.....	3
10A.....	4
10B.....	4
10C.....	4
10D.....	4

PROCEDURE

1. Adjust PRESEL for maximum receiver noise level.
2. Turn FUNCTION switch to MOX position with meter in IC position.
3. Rotate MIC GAIN control until meter rises just above normal idling current. (50MA)
4. Rotate PRESEL control for maximum meter reading. (Caution: if meter reading exceeds 0.2 reduce MIC GAIN control)
5. Rotate PLATE control for minimum meter reading. (Dip plate).
6. Return FUNCTION switch to STBY.

The transmitter is now pre-tuned to the desired frequency. Final peak tuning is accomplished by carefully following the final tuning procedure.

FINAL TUNING

CAUTION

EXCEEDING THE TIME LIMITS NOTED DURING FINAL TUNING WILL RESULT IN DESTRUCTION OF THE FINAL OUTPUT TUBES.

1. Set meter to P.O. position, FUNCTION switch to STBY, MODE switch to CW.
2. Momentarily set FUNCTION switch to MOX (10 seconds maximum), adjust PRESEL for maximum meter reading. Return FUNCTION switch to STBY.
3. Momentarily set FUNCTION switch to MOX (10 seconds maximum), increase or decrease LOADING slightly for maximum meter reading. Return FUNCTION switch to STBY.
4. Momentarily set FUNCTION switch to MOX (10 second maximum), adjust PLATE for maximum meter reading. Return FUNCTION switch to STBY.
5. Repeat steps 3 and 4 until maximum meter reading is obtained.

The transmitter is now peaked to maximum output. Return meter to IC position and set MODE switch to desired operating position.

SSB OPERATION

NOTE: Key jack must be removed from transmitter when operating in the side band or AM mode.

Set up the transceiver operation as previously described. Set the METER switch to ALC position. Set the FUNCTION switch to MOX and adjust the MIC GAIN control until the meter kicks up to midscale of green colored portion speaking into the microphone normally. Set the FUNCTION switch to desired operation, MOX (manual), PTT (push-to-talk), or VOX (voice control). For VOX operation, set the FUNCTION switch to VOX position, and advance VOX GAIN control under top cover until voice actuates the transceiver. If the VOX relay actuates with the output from the speaker, increase the ANTITRIP control to the minimum point to prevent the speaker output is tripping the VOX. Do not use more VOX gain or more ANTITRIP gain than necessary. Adjust the DELAY control under top cover for suitable release time constant.

NOTE: The meter can not follow speech speed, so the reading will show only around 250 ma for normal speech conditions, however, peak current is approximately 2 times the meter reading.

CW OPERATION

Using the two contact jack supplied with the accessory pack, connect key as shown in illustration on page 12.

Most relay type automatic keyers can be connected into the FT sx 400 for break-in operation without modification.

SIDETONE ADJUSTMENT

CW sidetone level may be adjusted by rotating the tone level potentiometer located on the main circuit board under the top cover. NOTE: Do not disturb setting of adjacent paint marked controls.

NOTE: Insertion of key jack automatically disconnects bias supply to final output tubes, therefore, with key jack installed bias idling current will not be indicated on meter.

AM OPERATION

NOTE: Key jack must be removed from transmitter when operating in the side band or AM mode.

Set up the transceiver as described in transmitter tuning. Set meter to IC, MODE switch to AM position. Momentarily set FUNCTION switch to MOX. Meter should read 150 ma. If meter indicates other than 150 ma adjust the AM control under top cover until the correct reading is obtained.

Adjust the MIC GAIN control until the meter reading kicks slightly on speech peaks. Do not draw more than 150 ma, otherwise the PA tube will be damaged immediately.

TUNING PROCEDURE-CW

Set up transceiver as described in transmitter tuning. After completion of final tuning, install key jack in rear apron of transceiver. Set MODE switch to CW and FUNCTION switch to MOX. The transceiver is now set up for manual CW operation. After completing a transmission the FUNCTION switch must be returned to STBY position for receive operation. For break-in operation, simply set FUNCTION switch to VOX position for transmit and receive.

SERVICE INSTRUCTIONS

WARNING

Dangerous voltages are present, therefore extreme care is essential. Be sure that all power is disconnected before working in the chassis. Check the high voltages in the capacitors by shorting the high voltage line to ground with an insulated screw driver. The transceiver has been aligned and calibrated at the factory with proper test instruments and should not require realignment. Service or replacement of a major components may require subsequent realignment, but do not attempt to make any alignment unless the operation of the transceiver is fully understood. To remove the transceiver chassis from the cabinet, remove the six screws around the cabinet and two screws on the bottom of the cabinet. From the rear, push the chassis forward until front frame slides out of the cabinet. Holding the front panel at the edge, carefully slide the chassis out of the cabinet.

VOLTAGE AND RESISTANCE MEASUREMENTS

The table lists voltages and resistances at all tube sockets. These values are measured with a VTVM with all tubes installed in their respective sockets.

All measurements should be made from socket pins to ground.

Adjust transistor voltage stabilizer to exactly 9 volts with VR-202 on the printed board.

TEST EQUIPMENT REQUIRED

A signal generator, a vacuum tube volt ohm meter with RF probe, a general coverage communication receiver, and a 500 watt dummy load.

TRANSMITTER ALIGNMENT

- 1) Disconnect the high voltage (860 volts) by unsoldering the lead at rectifier socket, and also the screen voltage by unsoldering the connection at pin 3 of the two tube sockets.
- 2) Connect VTVM RF probe to pin 5 of V5.
- 3) Set the MODE switch to USB or LSB, and the FUNCTION switch to MOX position. Adjust carrier balance potentiometer VR, 201 on the main print board for minimum VTVM indication.
- 4) Advance MIC GAIN control two positions, and turn the MODE switch to TUNE.
- 5) Adjust PRESELE control for maximum VTVM reading.
- 6) Adjust the MIC GAIN control during transmitter alignment to keep VTVM reading at 15 volts to avoid saturation of the circuits.
- 7) Start with both slugs of L203 nearly out and peak primary and secondary of L203 for peak VTVM reading.
- 8) Same as in 7, adjust slugs of L204.
- 9) Set main tuning dial to center i.e. 250 Kc, and adjust top slug of L202 for peak VTVM reading. Set the main tuning dial to upper end (500 Kc), and adjust bottom slug for peak VTVM reading. Repeat this procedure two or three times.
- 10) Set the BAND switch to the 80 meter band, the main tuning dial to the center (250 Kc), and the PRESELE control at center. Adjust the slugs of L901 & L1001 for peak VTVM reading. Adjust the slugs on all appropriate bands from 40 to 15 meters using the same procedure. Set the BAND switch to 10B and the main tuning dial at upper edge, and adjust L905 and L1005 for peak VTVM readings.
- 11) Disconnect the VTVM from pin 5 of V5, and connect it to pin 2 of V202. Set the BAND switch to 10D and adjust slug of L3 for peak VTVM reading. Set the BAND switch to 10C and adjust TC1101 for peak VTVM reading. Adjust TC1102 for 10B, TC1103 for 10A, TC1104 for 15 and TC1105 for the 20 meter band, for peak VTVM reading. For the 40 meter band, adjust L4 for peak VTVM reading. For the 80 meter band, adjust TC-1106 for peak VTVM reading. Disconnect VTVM.
- 12) Connect VTVM RF probe from pin 1 of V203 to ground. Set the main tuning dial at center. Adjust L207 for peak VTVM reading. Disconnect VTVM from pin 1 of V203 socket.
- 13) Turn the FUNCTION switch to OFF. Restore unsoldered PA screen grid and high voltage wire.
- 14) Connect the transceiver output to a 50 or 75 ohms dummy load. Set the main tuning dial at center, and tuneup the transceiver on 80 meter band as described. Adjust MIC GAIN control setting to keep PA current less than 100 ma. Readjust L1001 for peak meter reading. Readjust L1001 to L1005 for appropriate BAND settings.
- 15) Tune the transceiver to maximum output on any band, then turn MODE switch to LSB or USB. Disconnect dummy load from output. IC shows idle current approximately 50 ma. Rotate PLATE control, LOADING control, and PRESELE control through range. Proper neutralization is indicated when no change of meter reading is observed. If it is not so, the adjustment of TC1 is required. The neutralizing capacitor TC1 must be adjusted in small increments on an adjust and try basis. The driver stage is neutralized by a small capacitor made by twist two wires.
- 16) Tune the transceiver to maximum output at 14,180 Kc. To measure spurious radiation, use the S-meter of other receiver and tune it to 14,220 Kc where a spurious radiation can be heard. Adjust Tc-203 for minimum S-meter reading without decreasing power output of the transceiver. Adjust TL-401 for minimum S-meter reading.

RECEIVER CIRCUIT ALIGNMENT

If the transmitter circuits are aligned first, the most alignments will be completed for the receiver. The only alignment remaining for the receiver circuits are the last IF stage transformer L205, antenna input transformer L801 to L805, trap coils L806 and L906, and S meter zero set.

- 1) Connect signal generator output to the antenna terminal. Set the BAND switch to 80 meters, and receive 3,750 Kc signal from signal generator. Adjust PRESELE control for peak S meter reading. Adjust L801 for peak S meter reading. Adjust coils L802 to L805 at 7,250, 14,250, 21,250, 29,000 Kc respectively for peak S meter reading.
- 2) Tune the receiver circuit to 7,500 Kc incoming signal, and leave controls as is. Apply 5,700 Kc signal generator output to antenna terminal. Adjust L806 and L906 for minimum S-meter reading.
- 3) Tune the receiver to incoming signal at any band, and adjust slugs of L205 for peak S-meter reading.
- 4) Disconnect signal generator from antenna terminal, and set the RF GAIN control to fully clockwise. Adjust S-meter zero set under the top cover until the S-meter indicates full scale, i. e. S zero.

TRANSMITTER SIGNAL LEVEL

The following table shows the measuring points and normal signal levels. Before making measurements, set MODE switch to CW and unsolder the lead from pin 3 of V5, and V6 sockets. Set the FUNCTION switch to MOX. Plug-in key to key-Jack and close key to measure the signal level.

TEST POINT	FREQUENCY	VOLTAGE
V207 — pin 3	3,178.4 Kc.	1 volt
V201 — " 1	Variable	0.6 volts Function sw. STBY
V3 — " 1	X-tal frequency selected	0.5 — 1 volts
V207 — " 7 ✓	3,178.4 Kc.	5.5 volts
V204 — " 1	"	0.03 volts
V204 — " 5	"	5.5 volts
V201 — " 5	Variable IF	9.0 volts
V3 — " 5	Transmit frequency	10.0 volts
V5 — " 5		33.0 volts

Voltages given in the table are nominal and may vary $\pm 20\%$.

RECEIVER SIGNAL LEVEL

The following table shows test points and nominal signal level to produce S-9 reading on S meter.

SIGNAL GENERATOR CONNECTION POINT	SIGNAL GENERATOR FREQUENCY	SIGNAL GENERATOR OUTPUT LEVEL
V205 — pin 1	3,180 Kc	100 db
V204 — "		75 db
V203 — " 7	5,470 Kc	77 db
V201 — " 1		50 db
V1 — " 1	14,255 Kc	47 db
Antenna terminal		34 db
Oscillator injection voltages		
V213 — " 7	3,178.4	4 volts
V203 — " 1	Variable	3
V202 — " 1	Crystal selected	1—2 volts

The receiver was tuned to 14.255 Kc for these measurements and the test signal injected at indicated test points. Signal generator output levels are taken from signal generator attenuator. All values are nominal and may vary $\pm 20\%$ without degrading performance.

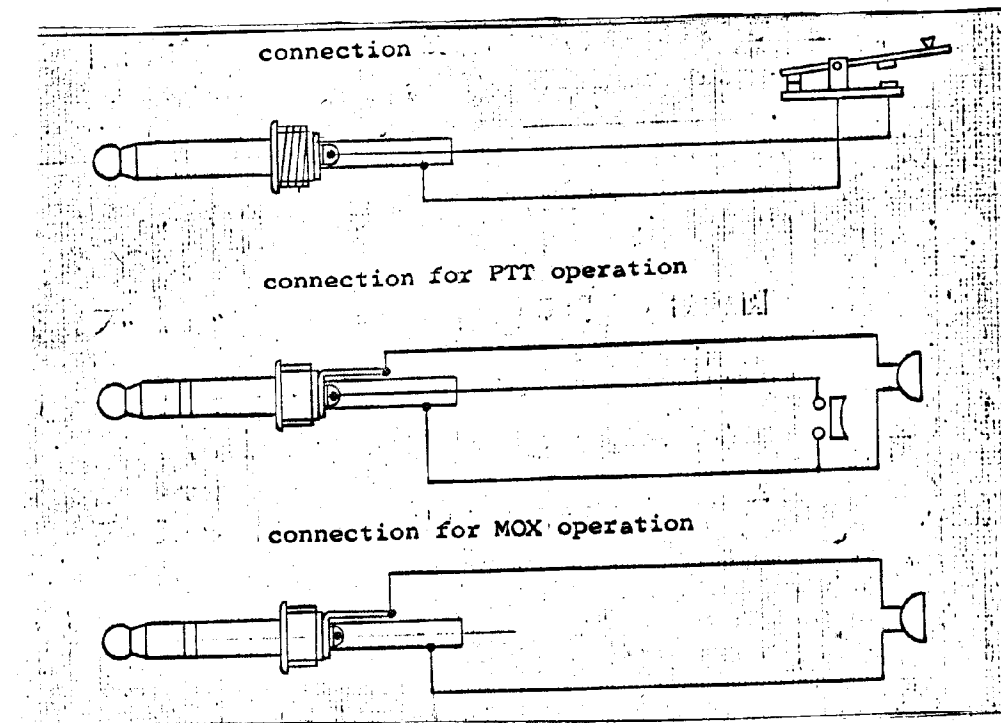

Ground lead for microphone should be wired separately and connected together to the ground lead of PTT switch at plug terminal.

TROUBLE SHOOTING GUIDE

DEFECT	POSSIBLE CAUSE
PA idling current unstable:	<ol style="list-style-type: none">1. Defective V5 and V6.2. Defective Bias supply including bias potentiometer.
Insufficient load:	<ol style="list-style-type: none">1. PRESELE improperly tuned.2. BAND. switch improperly set.3. Antenna not resonant at frequency.4. Defective antenna or transmission line.5. V3, V4, V5, V6 defective.6. Defective rectifier.
Insufficient carrier suppression:	<ol style="list-style-type: none">1. Defective V207.2. Carrier balance control improperly set.3. Defective crystal X201 or X202.4. Carrier frequency improperly set.
Distorted transmitted signal:	<ol style="list-style-type: none">1. Excessive MIC GAIN adjust.2. V7 defective.3. D2, D3 defective.4. Incorrect neutralization.
Insufficient drive or no drive:	<ol style="list-style-type: none">1. Defective rectifier.2. Defective V204, V201, V3, V4, V5.3. Defective crystal.
Low receiver sensitivity:	<ol style="list-style-type: none">1. Antenna relay back contacts defective.2. Defective V1, V201, V203, V204, V205
VOX unstable:	<ol style="list-style-type: none">1. Defective V2092. Improper setting of VOX GAIN & ANTITRIP controls.

VOLTAGE CHART

RECEIVE (USB)

TRANSMIT (USB)

TUBE	PIN	1	2	3	4	5	6	7	8	9	10	11	12
V 1	6 B Z 6	—	1	AC 6.3	0	150	100	0					
V 2	6 B A 6	—	0	AC 6.3	0	105	105	0					
V 3	6 A H 6	—	0	AC 6.3	0	340	140	—					
-100													
V 5	6 K D 6	AC 6.3	—	145	0	-150	0	0	0	-150	0	145	0
V 6	6 K D 6	AC 6.3 V	—	145	0	-150	0	0	0	-150	0	145	0
V 7	VR105MT	105	0	—	0	105	0	0					
V201	6 C B 6	—	0	AC 6.3	145	145	0						
V202	6 C B 6	—	2.5	AC 6.3	0	145	90	0					
V203	6 B E 6	—	0.8	AC 6.3	0	145	65	—					
V204	6 B A 6	—	0.8	AC 6.3	140	65	0.8						
V205	6 B A 6	—	0.8	AC 6.3	140	60	0.8						
V206	1 2 A U 7	80	—	9	0	0	80	—	3.4	AC 6.3			
V207	7 3 6 0	—	160	-140	0	AC 6.3	105	105	9	9			
V208	1 2 A X 7	80	—	1	AC 6.3	AC 6.3	100	—	1	0			
V209	1 2 A U 7	40	—	1.7	AC 6.3	AC 6.3	280	—	50	0			
V210	6 B M 8	—	9	—	0	AC 6.3	140	145	1.2	80			
V211	6 B A 6	—	2.4	AC 6.3	0	140	105	2.4					
V212	6 U 8	95	—	45	AC 6.3	0	75	8	8	-150			
V213	1 2 A U 7	100	—	4	0	0	45	—	4	AC 6.3			
V212	TUNE6U8	95	—	45	AC 6.3	0	75	—	—	—			

FT-DX-400

PARTS LIST

C-CAPACITOR			
2, 10, 30, 215, 216, 801	150P 500W V	25	100P 1KV MICA
2100~2102	±10% F. M.	299	500μ 15W V
3, 6, 32, 212, 219, 233,	100P 500W V	2107	1 μ 15W V
234, 239, 273, 412, 312	±10% F. M.		ELECTROLYTIC
701, 704, 1005, 1104, 2106		309, 401, 407, 411, 415	0.01 50W V
4, 205, 209, 220, 227, 71	1000P 500W V	702, 703, 705, 706	DISC
251, 303, 306, 307, 407	±10% F. M.	402, 1004, 2109	5 P 500W V
7~9, 15, 23, 24, 26~28, 31	0.01 500W V		±10% F. M.
37, 38, 40, 41, 43, 44, 83	DISC	404	20 P U J
49~52, 55~60, 67~70, 72, 77			CERAMIC
206, 208, 213, 214, 218		414	5 P U J
221, 222, 225, 228, 229			CERAMIC
231, 235, 238, 242, 244		501~504, 509~512	0.015 1.4 KV
245, 247~249, 252, 253			DISC
256, 259, 261, 262, 264		601, 602	80 μ 450W V
265, 269, 274~276			ELECTROLYTIC
284, 286~297, 2103~2105		603	40 μ × 3 400W V
513			ELECTROLYTIC
11, 74, 89, 246, 281, 902	10P 500W V	2108, 803	80 P 500W V
1101	±10% F. M.		±10% F. M.
12, 81	3P 500W V	29, 47, 86	300 P 500W V
	±10% F. M.		±10% F. M.
13, 88, 201, 304, 308	50P 500W V	283	0.005 500W V
802, 805	±10% F. M.		R-RESISTOR
14, 301, 310, 409, 410	470P 500W V	1, 29, 234, 267, 285, 2108	1MΩ ½W
806	±10% F. M.	2, 226, 254, 259	470K ½W
32	50P 1KV	263, 265, 274, 299~	
	MICA	2101, 2103, 2109, 501~	
48, 84, 87, 258	200P 500W V	508, 601, 602	
	±10% F. M.	3, 21, 24, 36, 39, 42, 44	56 ½W
34	40P 500W V	216, 221	
	±10% F. M.	4, 6, 11, 13, 20, 201, 204, 207	1 K ½W
35, 236, 408	250P 500W V	209, 214, 219, 230, 235	
	±10% F. M.	237, 244, 280, 289, 295	
36	0.047 600W V	405, 410	
	TUBULAR	5, 7, 9, 10, 14, 28, 47, 236	47K ½W
39, 42, 405	0.05 50W V	238, 240, 241, 243, 245	
	DISC	246, 248~250, 260, 268, 278	
45	0.005 1.5KV	291, 292, 2104	
	MICA	8, 304,	33K ½W
46	0.001 1.5KV	12, 33, 202, 205, 208, 210	100K ½W
	MICA	215, 220, 228, 233, 239	
61, 250	0.05 50W V	256, 257, 261, 266, 288, 287	
	MYLAY	290, 2106, 302, 309, 515	
63, 64	0.01 1.4KV	15, 279, 703, 27, 408, 409	220 ½W
	DISC	16	47K 3W
65, 66	20 μ 150W V	17	4.7K 5W
	ELECTROLYTIC	34	15K 2W
73	20 μ 350W V	19, 37, 253, 262, 272, 293	2.2K ½W
	ELECTROLYTIC	297, 298, 2102, 402	
75, 82, 243, 1005	20P 500W V	211, 217, 407, 701	22K ½W
	±10% F. M.	2116	5.1K ½W
33, 403, 406, 1102	30P 500W V	22, 276, 283, 2105, 705	10K ½W
305, 1003	±10% F. M.	301, 308, 401, 514, 2112	
804, 901, 1103	70P 500W V	23, 26	56 1W
	±10% F. M.	306	27K ½W
237	0.5 50W V	31	470 5W
	MYLAR	32	3.6K 5W
903	60P 500W V	35	33K 1W
	±10% F. M.	38	1.5K ½W
255, 257, 260, 268	10 μ 15W V	40, 41, 212, 282, 303, 310	100 ½W
	ELECTROLYTIC	203, 2114	330 ½W
263, 266, 267	0.1 50W V	46, 213	15K ½W
	MYLAR	224	5.6M ½W
270	10 μ 25W V	225, 269, 271,	2.2M ½W
	ELECTROLYTIC	409, 294	470 ½W
303	2000P 500W V	242	150K ½W
	±10% F. M.	247, 258, 305, 307, 229, 2113	4.7K ½W
298	200 μ 25W V	252, 264, 270, 273, 2110	220K ½W
280	0.2 μ 50W V	275	220 1W
85	0.0047 500W V	218	5.6K 1W
272, 2110 2111	10 μ 150W V	18	6.8K 2W
78, 2112	1 μ 150W V		

406	8.2K	1/2W		RL-RELAY	
403	18K	1/2W	2	ANT AR 42 DC100V	
277	150	1/2W	201	VOX SRE-5D11 DC100V	
284	47K	1W		PL-PILOT LAMP	
296, 702	3.3K	1/2W	1, 2	6.3V	6.3V
2115	5.6K	1/2W		PLH-PL HOLDER	
513	4.7K	1W	1,2		S-E 0104
516	22K	1W		F-FUSE	
517	5.6	3W	1		10A GLASE
704	10	1/2W		FH-FUSE HOLDER	
	VC-VARIABLE CAPACITOR		1		S-N 1001
1	PRESELECTOR	(330P+24P)×3		T-TRANSFORMER	
2	PLATE	270P 1.5KV	1		O.P.T
3	LOAD	430P×2	2		POWER
401	VFO	20P×3		CH-FILTER CHOKE	
	TC-TRIMMER CAPACITOR		1		2.5H 150mA
1		10P 1.5KV AIR		M-METER	
204, 205, 701~704, 203		20P CERAMIC	1		MRA-45 1mA
1101~1109				XS-CRYSTAL SOCKET	
301	50P	CERAMIC	1, 2, 3, 201, 202, 301		HC-6/U TYPE
302	40P	CERAMIC		L-INDUCTOR	
401	30P	600V AIR	1		RFC 2mH
402	10P	PISTON	2, 6, 7		TV-245 250μH
	TR-TRANSISTOR		14		140μH
201		2 S C 504	301, 302		RFC 4mH
202, 401, 402, 701		2 S C 372			
301~304		2 S C 367		VS-TUBE SOCKET	
	D-DIODE		1, 2, 3		7P TR102 CO 1
1, 205, 206, 212, 204, 203		1S1007	4		9P TS103 CO 1
2, 3, 207~211, 213, 202		SH-1 SILICON	5, 6		COMPACTRON S-B0703-2
6	1S143	15V ZENER	7		7P TS102 UO 2
215	1S331	6V ZENER	201, 202, 203, 204		7P S-B0933-2
401, 701	1S145	VARICAP	205, 211		
501~508	SA-2C	SILICON	206, 207, 208, 209		9P S-B 1330-2
509~512	SD-1C	SILICON	210, 212, 213, 07-2		9P S-B 1307-2 2
513	SD-1Y	SILICON		PB-PRINT BOARD	
	VR-VARIABLE RESISTOR		PB1001		# 3401001
1, 10		50Ω B 1/6W			GENERATOR
2-9	DOUBLE	500KA-10KC	PB1002		# 3401002
3, 5		50K B 1/6W			CALIBLATOR
4		20K B 1/6W	PB1030		# 3401003
6, 7, 8		500K A 1/6W			VFO
11		20K B 1/4W	PB1004		# 3401004
12		3M A 1/8W			RECTIFIER
201, 202		1K B 1/6W	PB1005		# 3401005
203		500K A 1/6W			ELECTROLYTIC
301		10K B 1/6W	FP1006		# 3401006
	S-SWITCH (SEC.-POLES-POS.)				FIX OSC
1		12-12-11	PB1007		# 3401007
2		1-1-3			COIL ASSE
3		1-2-3	PB1022		# 3401022
4		4-8-5			TRIMMER ASSE
5		1-4-7		K-KNOB	
6		2-4-6	1, 2, 3, 4		FT-25F
7		1-1-3	5, 6, 7, 8, 9, 10		FT-25
			11		DIAL
	J-JACK			XF-CRYSTAL FILTER	
1		S G 4601	201		XF-3
2, 7~11		RCA JACK NO7017		X-CRYSTAL	
3		PHONE S-G 3207	1	80m	HC-18/U 9.22MC
4		ANT JSO-239	2	40m	" 12.72MC
5		REMOT 11P	3	20m	" 19.72MC
6		S G 3207	4	15m	" 26.72MC
	P-PLUG		5	10mA	" 33.72MC
1		S-H 3601	6	10mB	" 34.22MC
2, 7~11		RCA NO7017	7	10mC	" 34.72MC
3		PHONE S-H 3001	8	10mD	" 35.22MC
4		ANT MP-7 INCH	201	LSB	HC-6/U 3181.5MC
5		REMOT 11P	202	USB	" 3178.5KC
6		KEY S-H 3601	301	CAL	HC-13/U 100KC
12		AC 2P			

RESISTANCE CHART

(Ω) USB

	TUBE	PIN	1	2	3	4	5	6	7	8	9	10	11	12
V 1	6 B Z 6		∞	60	0	0	5 K	5 K	0					
V 2	6 B A 6		50K	0	0	0	5 K	5 K	0					
V 3	6 A H 6		∞	0	0	0	30K	5 K	1 K					
V 4	6 K D 6		0	0	5 K	0	50K	0	0	0	50K	0	5 K	0
V 5	6 K D 6		0	0	5 K	0	50K	0	0	0	50K	0	5 K	0
V 6	6 K D 6		0	0	5 K	0	50K	0	0	0	50K	0	5 K	0
V 7	VR105MT		5 K	0	∞	0	5 K	∞	0					
V201	6 C B 6		∞	300	0	0	6 K	6 K	0					
V204	6 C B 6		∞	1 K	0	0	6 K	200K	0					
V203	6 B E 6		30K	100	0	0	6 K	30K	∞					
V204	6 B A 6		∞	100	0	0	6 K	10K	100					
V205	6 B A 6		∞	100	0	0	6 K	10K	100					
V206	1 2 A U 7		20K	60K	∞	0	0	20K	60K	1 K	0			
V207	7 3 6 0		1 K	0	0	0	0	40K	40K	30K	30K			
V208	1 2 A X 7		200K	∞	5 K	0	0	∞	∞	2 K	0			
V209	1 2 A U 7		∞	∞	2 K	0	0	50K	∞	10K	0			
V210	6 B M 8		—	200	∞	0	0	5 K	5 K	2 K	∞			
V211	6 B A 6		60K	200	0	0	6 K	5 K	20K					
V212	6 U 8		∞	∞	∞	0	0	100K	∞	∞	60K			
V213	1 2 A U 7		20K	∞	1 K	0	0	100K	∞	1 K	0			
V212	TUNE6U8		∞	∞	∞	0	0	100K	2 K	10K	60K			

ACCESSORY SOCKET CONNECTION

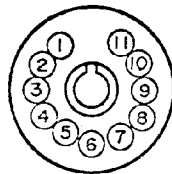

- Pin 1 AC 6.3 VOLT
- 2 AC 6.3 VOLT
- 3 + 150 VOLT
- 4 + 300 VOLT
- 5 + 800 VOLT
- 6 - 100 VOLT
- 7
- 8 Ground
- 9 Relay Transmit
- 10 Relay Center
- 11 Relay Receiver

to ground for

FREQUENCY TABLE (Kc)

VFO Frequency	8500 8700	8800	8700	8500 8600	8500	8400	Local Frequency
Operating Frequency	3500	3600	3700	3800	3900	4000	9220
	7000	7100	7200	7300	7400	7500	12720
	14000	14100	14200	14300	14400	14500	19720
	21000	21100	21200	21300	21400	21500	21720
	28000	28100	28200	28300	28400	28500	33720
	28500	28600	28700	28800	28900	29000	34220
	29000	29100	29200	29300	29400	29500	34720
29500	29600	29700	29800	29900	30000	35220	

* Operating frequency=Carrier frequency+1.5 Kc for LSB

Carrier frequency-1.5 Kc for CW, USB & AM

Xtal frequency for crystal controlled operation is determined by following formula;

X=Local frequency-Operating frequency+3180 Kc

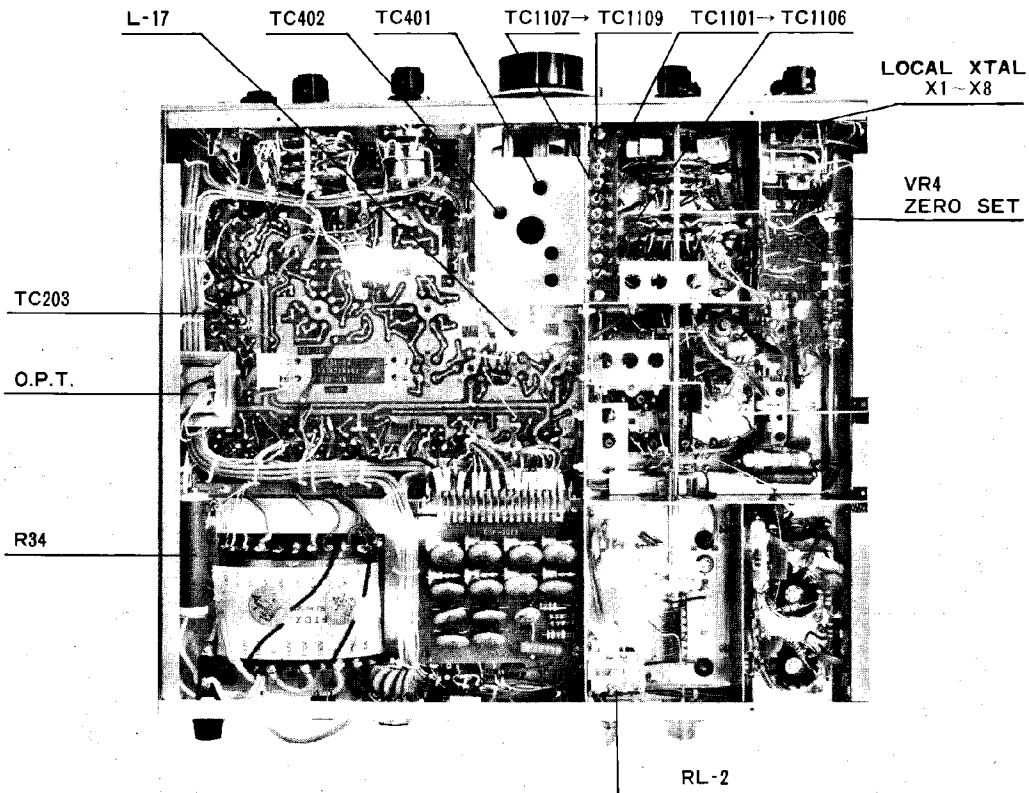
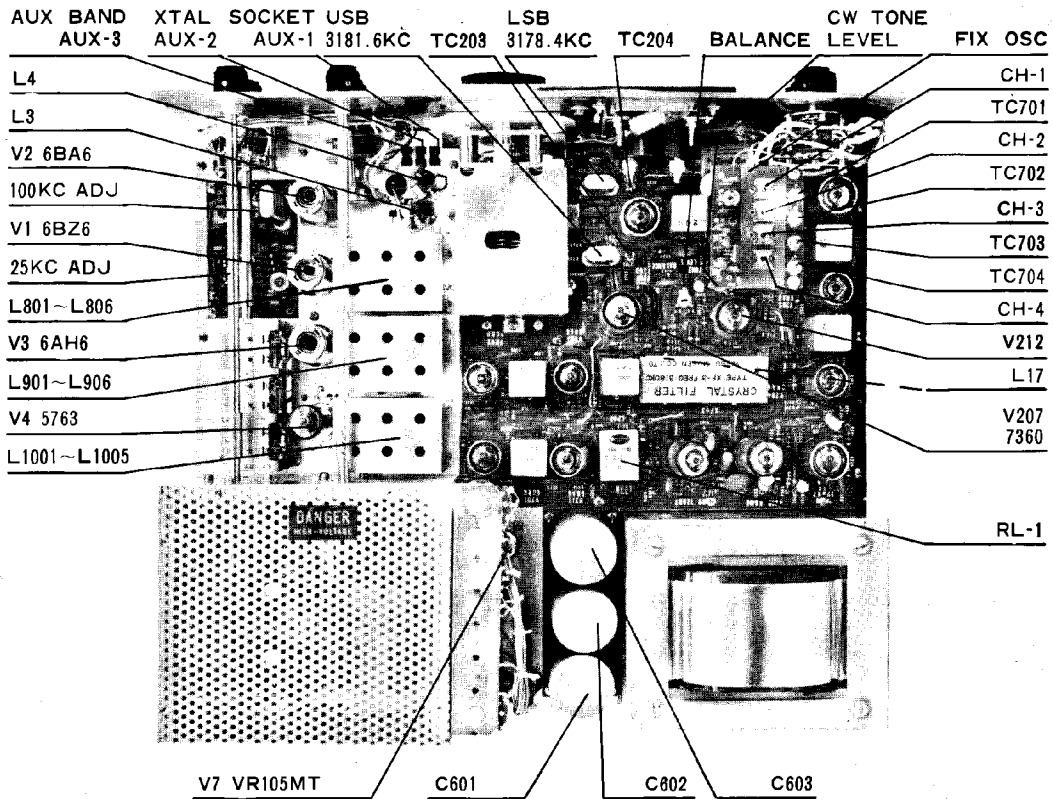

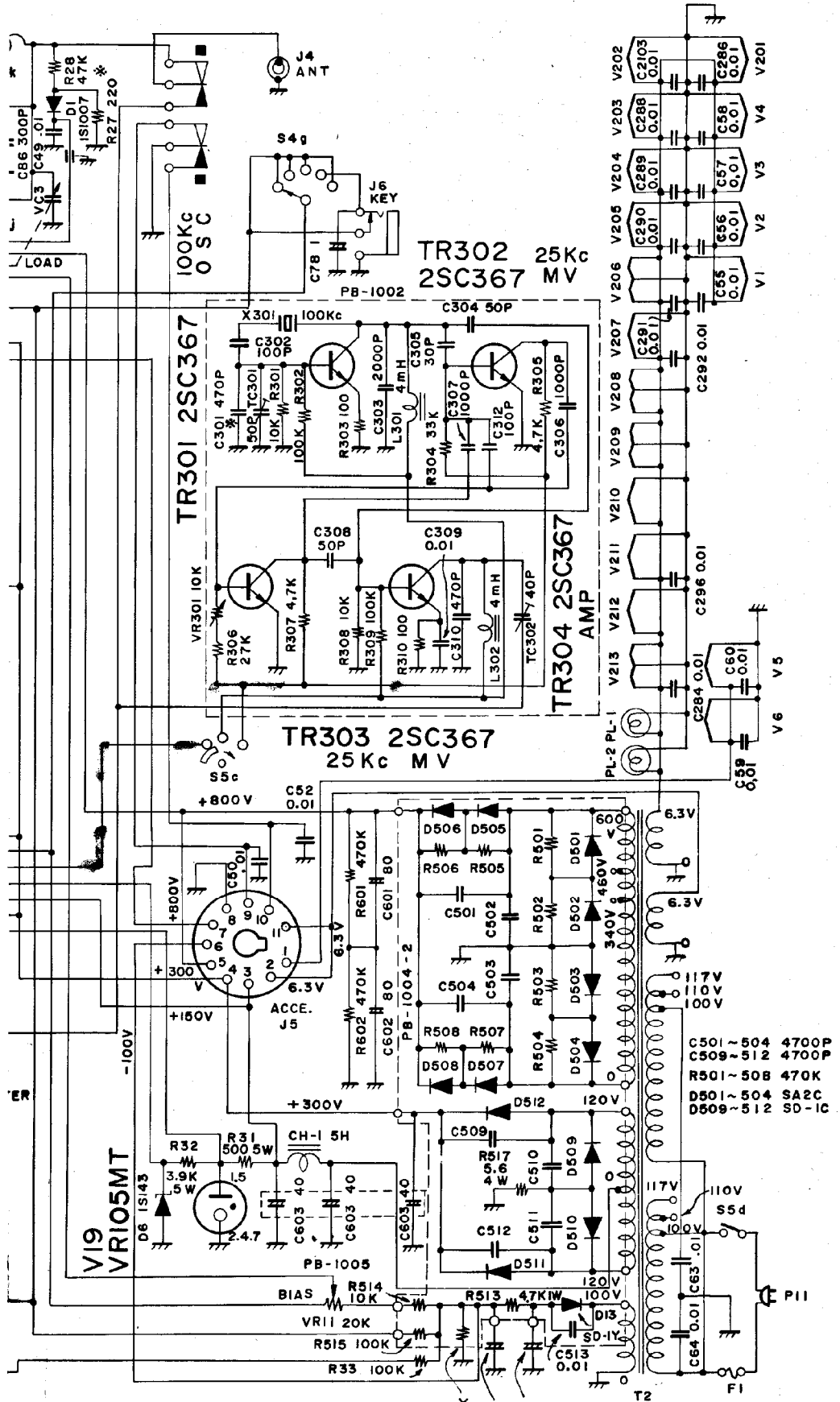

ES:
 ALL RESISTORS IN OHM. 1/2W ±10%
 UNLESS OTHERWISE NOTED.
 ALL CAPACITOR IN μF
 UNLESS OTHERWISE NOTED.
 *VALUE IS NOMINAL.

- C501 ~ 504 4700P
- C509 ~ 512 4700P
- R501 ~ 508 470K
- D501 ~ 504 5A2C
- D509 ~ 512 5D-1C

- R516 22K 1W
- C66 20
- C65 20

V5 6KD6 V6 6KD6
P A P A

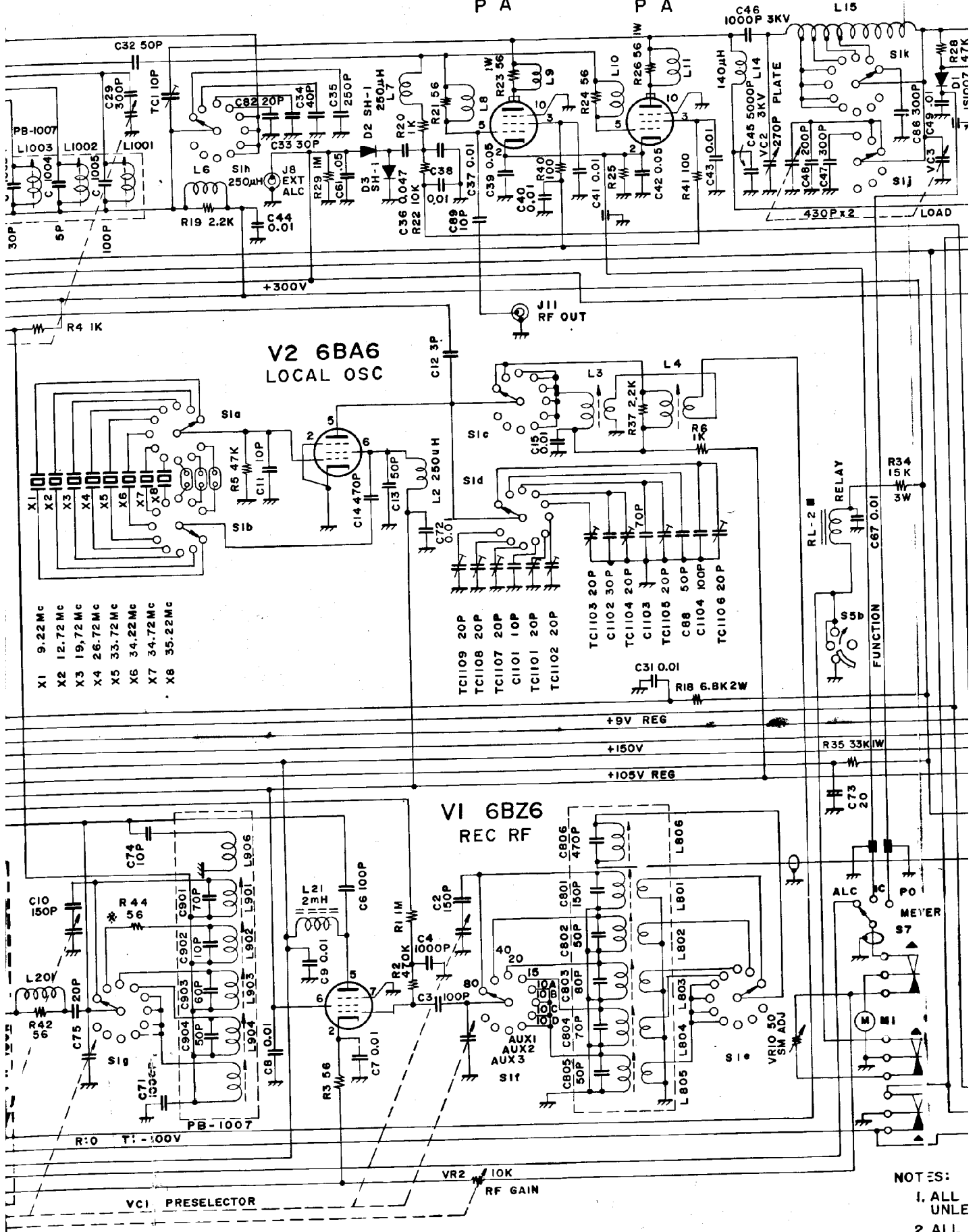

- NOTES:
1. ALL UNLE
 2. ALL UNLE
 - 3 * VAL

V201 6CB6
TRANS 1ST MIX

V3 6AH6
TRANS 2ND MIX

V4 6GK6
DRIVER

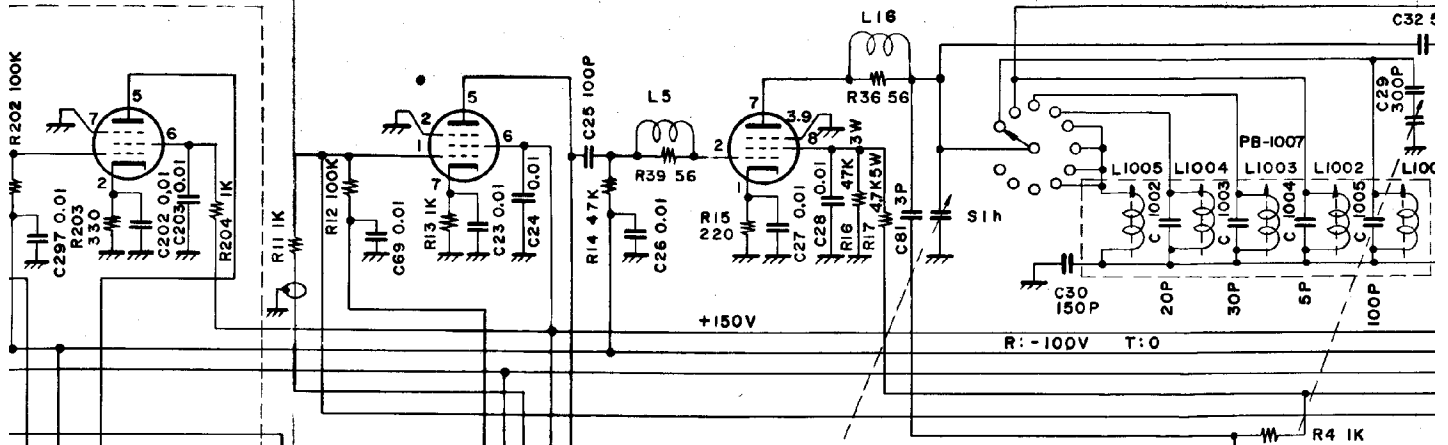

V211 6BA6
VFO BUFF

TR402 2SC372 VFO BUFF
TR401 2SC372 VFO OSC

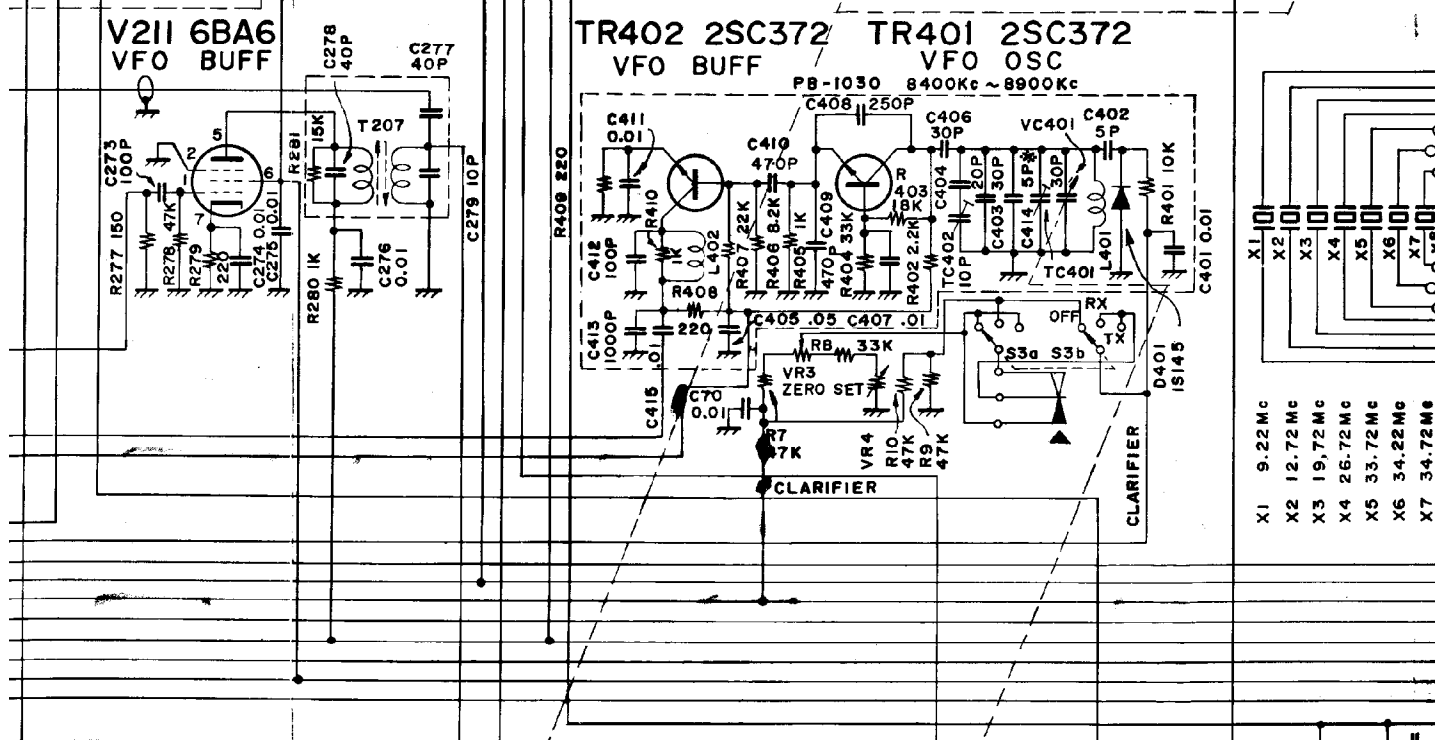

- X1 9.22 Mc
- X2 12.72 Mc
- X3 19.72 Mc
- X4 26.72 Mc
- X5 33.72 Mc
- X6 34.22 Mc
- X7 34.72 Mc

V204 6BA6
REC 2ND IF TRANS 1ST IF

V203 6BE6
REC 2ND MIX

V202 6CB6
REC 1ST MIX

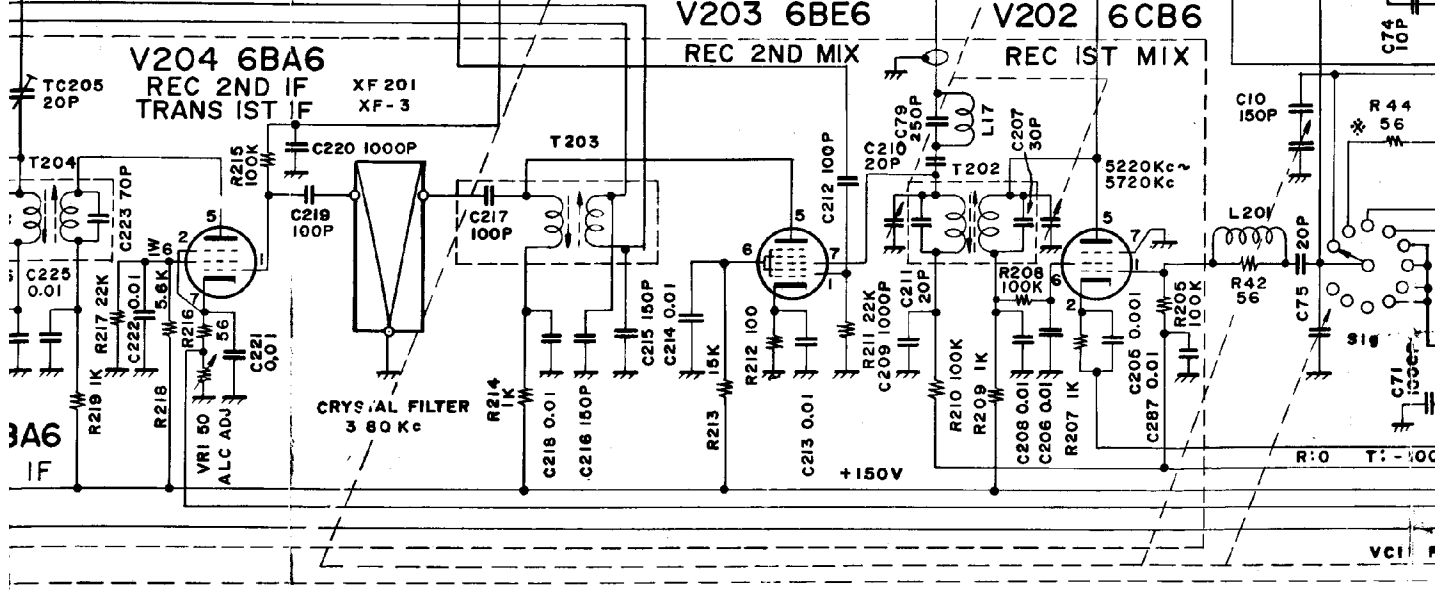

V208 12AX7
MIC AMP

V209a 12AU7
VOX AMP

